

**M8 male 0° with cable**

PUR 3x0.25 bk UL/CSA+drag chain 20m

Male straight

M8, 3-pole

Art-No. 7005 - M8 Lite - (plastic hexagonal screw) on request  
with cable sleeves

Plastic housings with good resistance against chemicals and oils.

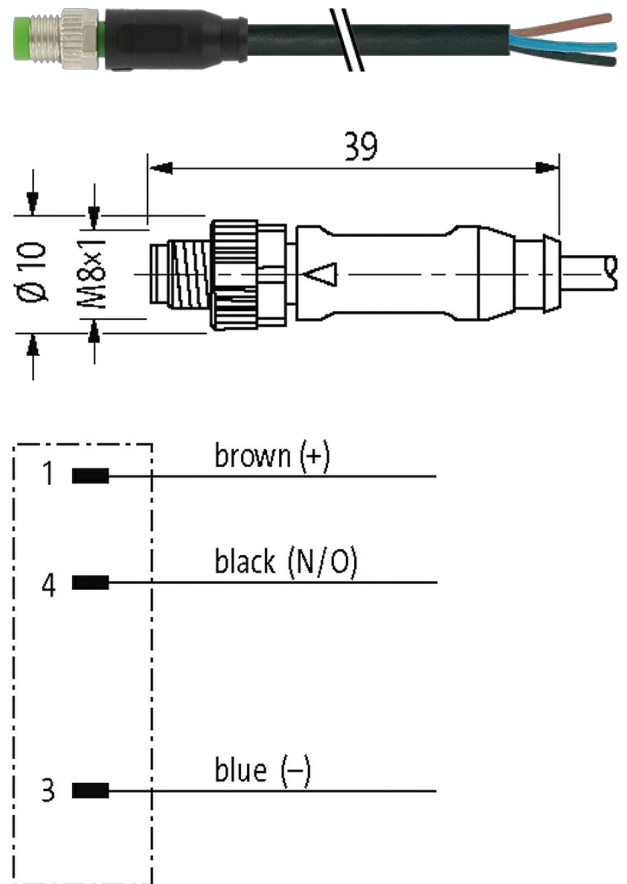
The resistance to aggressive media should be individually tested for your application. Further details on request.  
Further cable lengths on request.**Illustration**

Product may differ from Image

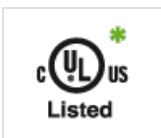
**Approvals**

cCSAus

\* only for products with UL/CSA approved cable

**Form**

Form 08001

**General data**

Standards DIN EN 61076-2-104 (M8)

Mounting method inserted, tightened

Material (contact)	Copper alloy
Material (contact surface)	Au
Pollution Degree	3
Stripping length (jacket)	20 mm
Temperature range	-25...+85 °C, depending on cable quality
<b>Cables</b>	
No./diameter of wires	3 × 0.25 mm <sup>2</sup>
Wire isolation	PP (br, bl, bk)
C-track properties	10 Mio.
Material (jacket)	PUR (UL/CSA)
Outer Ø	4.1 mm ±5%
Bend radius (moving)	10 × outer Ø
Temperature range (fixed)	-40...+80 °C
Temperature range (mobile)	-25...+80 °C
Cable identification	630
Cable Type	3 (PUR)
Approval (cable)	cURus (AWM-Style 20549/10493); CE conform
Cable weight [g/m]	26,40
Material (wire)	Cu wire, bare
Resistor (core)	max. 79 Ω/km (20 °C)
Single wire Ø (core)	0.1 mm
Construction (core)	32 × 0.1 mm (multi-strand wire class 6)
Diameter (core)	3 × 0.25 mm <sup>2</sup>
AWG	similar to AWG 24
Material (wire isolation)	PP
Material property (wire isolation)	CFC-, halogen-, cadmium-, silicone- and lead-free
Shore hardness (wire isolation)	70 ±5 D
Wire-Ø incl. isolation	1.25 mm ±5%
Color/numbering of wires	br, bk, bl
Stranding combination	3 wires twisted
Shield	no
Material (jacket)	PUR
Material property (jacket)	CFC-, halogen-, cadmium-, silicone- and lead-free, matt, low-adhesion, machine easy to process, abrasion-resistant, hydrolysis and microbial resistant
Shore hardness (jacket)	90 ±5 A
Outer-Ø (jacket)	4.1 mm ±5%
Color (jacket)	black
chemical resistance	good resistance to oil, gasoline and chemicals (EN 60811-404)
thermal resistance	flame retardant UL 1581 VW1 / CSA FT1 / IEC 60332-1, IEC 60332-2-2
Nominal voltage	300 V AC
Test voltage	2500 V AC
Current load capacity	to DIN VDE 0298-4
Temperature range (fixed)	-40...+80 °C, (+90 °C at max. 10 000 operating hours)
Temperature range (mobile)	-25...+80 °C, (+90 °C at max. 10 000 operating hours)
Bend radius (fixed)	5 × outer Ø
Bend radius (moving)	10 × outer Ø
No. of bending cycles (C-track)	max. 10 Mio. (25 °C)
Travel speed (C-track)	max. 3 m/s
Acceleration (C-track)	max. 10 m/s <sup>2</sup>
Torsion stress	±180°/m
No. of torsion cycles	max. 2 Mio. (25 °C)

Torsion speed	35 cycles/min
---------------	---------------

Jacket Color	black
--------------	-------

**Technical Data**

Operating voltage	max. 50 V AC/60 V DC
-------------------	----------------------

Operating voltage (only UL listed)	30 V AC/DC
------------------------------------	------------

Rated surge voltage	1.5 kV
---------------------	--------

Operating current per contact	max. 4 A
-------------------------------	----------

No. of poles	3
--------------	---

Material group	IEC 60664-1, category I
----------------	-------------------------

LED display	no
-------------	----

Locking of ports	Screw thread (M8×1 mm) recommended torque 0.4 Nm, self-securing
------------------	---

Compression gland	M8 (SW9)
-------------------	----------

Protection	IP65, IP66K, IP67 inserted and tightened (EN 60529)
------------	---

Locking material	Zinc die casting, matte nickel plated
------------------	---------------------------------------

Material	PUR
----------	-----

suitable for corrugated tube (internal Ø)	6.5 mm
---	--------

**Commercial data**

country of origin	DE
-------------------	----

customs tariff number	85444290
-----------------------	----------

EAN	4048879328906
-----	---------------

eClass	27279218
--------	----------

Packaging unit	1
----------------	---

**Sketch**

Male

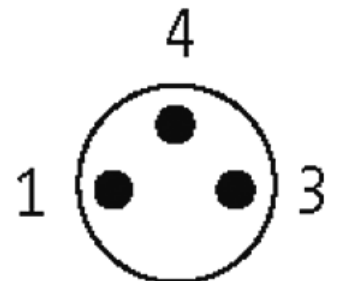

Product may differ from Image